



SOMBRANO® S+

INTERNATIONAL

PRODUCT DESCRIPTION
2016





SOMBRANO® S+



- Frame:** 8 rods made of natural anodized, with crank mechanism, (selflocking on both sides) and tilting rod for effortless tilting of the shade roof on both sides up to 54 degrees. The pole profile is oval 66 × 95 × 3 mm. M4 turnable ball-bearing base, powder-coated cast steel, is included.
- Frame colour:** Anodized natural
- Frameform:** Round or square
- Shade cover:** Self-tautening thanks to the flexible rod ends, available in material class 5 (100 % polyacrylic approx. 300 g/m²), material class 4 (100 % polyester approx. 250 g/m²)
- Flounce:** Not available
- Protective cover:** Included in the standard equipment

• Point of use • Fastenings

SOMBRANO®, Int. Patents reg.



Nominal size SOMBRANO® S+

	Size without flounce	Number of rods	Material class 4 Colours 400 – 499	Material class 5 Colours 500 – 699	Order no. Frame anodized natural
	cm				
○	Ø 350	8 parts			085 00 350 171
	Ø 400	8 parts			085 00 400 171
□	300 × 300	8 parts			085 00 310 171
	350 × 350	8 parts			085 00 351 171

Fixing option M4	
³ Base frame with castors M4, 150 kg, Ø 88 × 17 cm, anthracite	350 01 102 700
³ Weights set, 4 pieces 35001105600, cement, for base with castors 150 kg, (weight set approx. 99 kg)	350 01 103 600
³ Protective cover for base with castors 150 kg	350 01 602 600
Base M4, 120 kg, (for 8 plates 40 × 40 × 4 cm), 91 × 91 × 11.5 - 15.5 cm, galvanised steel (adjustable and levellable) (price without plates)	350 01 108 235
Base M4, 180 kg, (for 12 plates 40 × 40 × 4 cm), 91 × 91 × 15.5 - 19.5 cm, galvanised steel (adjustable and levellable) (price without plates)	350 01 108 335
Cover for base M4, 88 × 88 × 5 cm, brushed aluminium (imitation)	350 01 100 400
Set of castors for base M4 (maximum weight 240kg), Ø 5 cm, H= 5.5 cm, galvanised steel	350 01 100 500
³ Granite base M4, 120 kg, 90 × 90 × 17 cm, natural stone with castors	350 01 109 470
Ground socket M4, galvanised steel	350 01 226 510
Mounting plate M4 / M8, 30 × 30 × 1.5 cm, galvanised steel	350 01 226 921
Mounting plate M4 special, for installation height 50 – 149 mm, galvanised steel	350 01 226 932
Mounting plate M4 special, for installation height 150 – 350 mm, galvanised steel	350 01 226 930
Mounting plate M4 for isolated grounds, installation height made to measure, high-grade steel 1.4301 / 304	350 01 229 730
Wall console M4, extension 480 mm, galvanised steel	350 01 229 405
Wall console M4, extension 100 mm, galvanised steel	350 01 229 410
Slabs for base M4	
Slab set, 8 pieces, 40 × 40 × 4 cm, (ca. 110 kg), concrete	350 01 226 908
Slab set, 8 pieces, 40 × 40 × 4 cm, (ca. 115 kg), 4 pieces concrete, 4 pieces polished granite	350 01 226 909
Slab set, 12 pieces, 40 × 40 × 4 cm, (ca. 165 kg), concrete	350 01 226 907
Slab set, 12 pieces, 40 × 40 × 4 cm, (ca. 170 kg), 8 pieces concrete, 4 pieces polished granite	350 01 226 906
Protective cover, coated polyester fabric	
Protective cover with zip and rod for the SOMBRANO®, Ø 350 / 300 × 300	350 01 221 490
Protective cover with zip and rod for the SOMBRANO®, Ø 400 / 350 × 350	350 01 221 500
Miscellaneous items	
Rechargeable battery light Osyrion 6 for pole Ø 30 – 50 mm, battery charger with european plug (type C) included (1 accumulator included)	350 01 557 950
Rechargeable battery light Osyrion 4 for pole Ø 30 – 50 mm, battery charger with european plug (type C) included (1 accumulator included)	350 01 557 910
Spare accu, 3.6 V, 2500 mAh (for Osyrion 4 & 6)	350 01 557 920
¹ Base transporter for sockets weighing 120 kg, 180 kg, 240 kg, 430 kg and 620 kg	350 01 909 000

¹ while stocks last

³ only suitable for smooth, joint free surface coverings

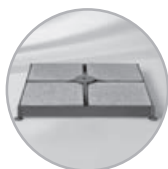

Base M4, 120 kg / 180 kg, galvanised steel



Cover for base M4

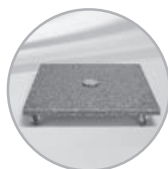

Granite base M4, 120 kg, natural stone with castors



Ground socket M4, galvanised steel

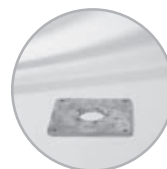

Mounting plate M4, galvanised steel



Mounting plate M4, special, for installation height 50–149 mm, galvanised steel



Mounting plate M4, special, for installation height 150–350 mm, galvanised steel

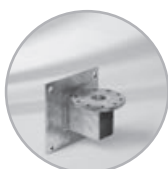

Wall console M4 extension 100 mm

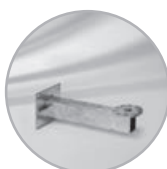

Wall console M4 extension 480 mm



Base with castors, round, 150 kg

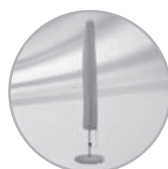

Protective cover with zip and rod



Osyrion 4 accu light



Osyrion 6 accu light



Base transporter for sockets

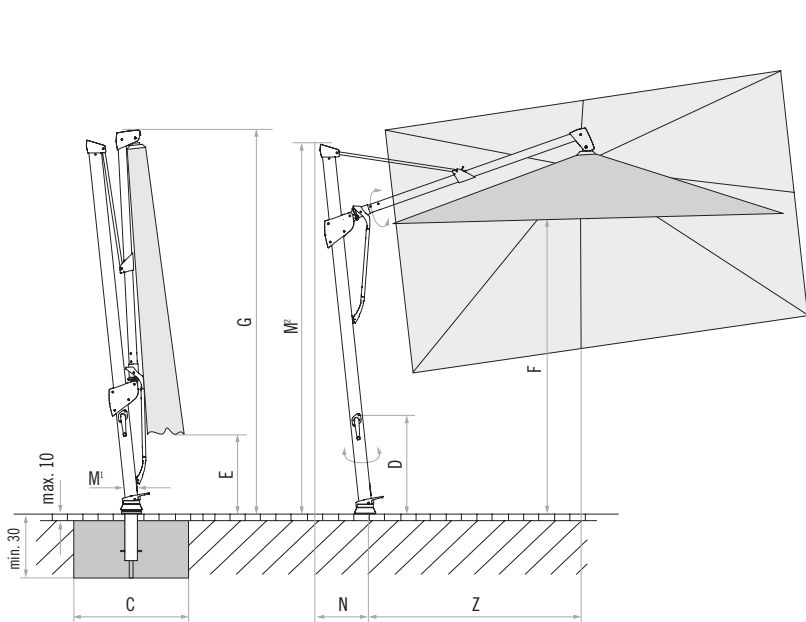

Loose cover max. 10 cm, concrete thickness min. 30 cm (pay attention to frost depth), water outflow

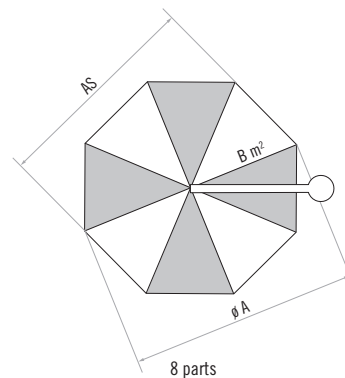

8 parts

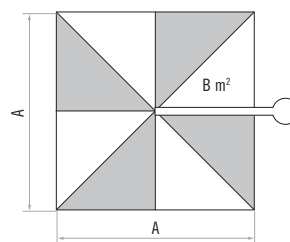

8 parts

Nominal size	Lateral distance	Pole Ø	Area covered	Crank height	Height closed	Clear headroom	Total height	Height of pole	Overhang at the back	Length of free-arm	Foundation	Recommended minimum weight for base	max. wind speed open perm.
cm	cm	cm	m ²	cm	cm	cm	cm	cm	cm	cm	cm	kg	km/h (wind force)
A	AS	M ¹	B	D	E	F	G	M ²	N	Z	C		
Ø 350	325	6.6 × 9.5	8.7	69	90	205	285	275	33	165	60 × 60	120	45 (6)
Ø 400	370	6.6 × 9.5	11.3	69	85	210	300	275	33	185	60 × 60	150	35 (5)
300 × 300	-	6.6 × 9.5	9.0	69	55	215	285	275	33	165	60 × 60	120	45 (6)
350 × 350	-	6.6 × 9.5	12.3	69	40	215	300	275	33	185	60 × 60	150	35 (5)

The listed measures represent extrapolated average values that may be slightly different on the product ($\pm 2\% \pm 5$ cm).

The height dimensions are based on the ground socket M4. With the base M4, 120 kg these vary by plus 11.5 cm and with the base M4, 180 kg by plus 15.5 cm.

The max. wind speed limits as per our separate sheet apply only if the sunshade canopy is in a horizontal position and if there is a fix ground anchorage.

In the presence of several sunshades, the minimum distance between one sunshade and another and between sunshades and walls shall be 20 cm.

Your nearest GLATZ representative:



Glatz

Shade in Swiss Quality

